

nitcom

2008

**Mobile
Climate
System
Fittings**

**NITCOM Israel Ltd.
NITCOM Inc.**

P.O. Box 4046
1012 Weisgal Street
Rabin Science Park
74140 Nes Ziona, ISRAEL
Telephone: 972-8-9462114
Facsimile: 972-8-9461725
E-Mail: nitcom@netvision.net.il

P.O. Box 422
New Cumberland, PA 17070 USA
Toll Free: 877-521-4030
www.nitcominc.com

nitcom

NITCOM Inc.

Exclusive Distributors

SANDEN INTERNATIONAL (Israel)

P.O. Box 4046
1012 Weisgal Street
Rabin Science Park
70400 Nes Ziona, ISRAEL

P.O. Box 1361
76113 Rehovot, ISRAEL
Telephone: 972-8-9462114
Facsimile: 972-8-9461725
E-Mail: nitcom@netvision.net.il
www.nitcominc.com

“Cooling Expertise for a Warming World”

All Rights Reserved 2008

INDEX

BEADLOCK FITTINGS.....	1 THRU 9
BARB WELD-ON FITTINGS.....	10
SPECIALTY FITTINGS.....	11 THRU 14
COMPRESSOR BLOCKS.....	15 THRU 17
NUMERICAL INDEX	18 THRU 20

PREFIX IDENTIFICATION

NA-BL.....	BEADLOCK (aluminum tube, steel nut and ferrule)
NS-BL.....	BEADLOCK (steel tube, steel nut and ferrule)
NA-RB.....	REDUCED BARRIER BEADLOCK (aluminum tube, steel nut and ferrule)
NS-RB.....	REDUCED BARRIER BEADLOCK (steel tube, steel nut and ferrule)





ILLUSTRATION	BLA	RBA	BLS	RBS	THREAD	A	B	PORT
 <p>STRAIGHT FEMALE FLARE (FF)</p>	NA1101BL	NA1101RB	NS1101BL	NS1101RB	5/8" - 18	6	6	
	NA1102BL	NA1102RB	NS1102BL	NS1102RB	3/4" - 16	8	8	
	NA1103BL	NA1103RB	NS1103BL	-----	7/8" - 14	10	10	
	NA1104BL	NA1104RB	-----	-----	1 1/16" - 14	12	12	
	NA1105BL	NA1105RB	NS1105BL	-----	5/8" - 18	6	8	
	NA1106BL	NA1106RB	-----	-----	3/4" - 16	8	10	
	NA1107BL	-----	NS1107BL	NS1107RB	7/8" - 14	10	12	
	NA1108BL	-----	NS1108BL	-----	3/4" - 16	8	6	
 <p>45 DEGREE FEMALE FLARE (FF)</p>	NA1111BL	NA1111RB	NS1111BL	-----	5/8" - 18	6	6	
	NA1112BL	NA1112RB	NS1112BL	-----	3/4" - 16	8	8	
	NA1113BL	NA1113RB	NS1113BL	-----	7/8" - 14	10	10	
	NA1114BL	NA1114RB	NS1114BL	-----	1 1/16" - 14	12	12	
	NA1115BL	-----	-----	-----	5/8" - 18	6	8	
	NA1116BL	-----	-----	NS1116RB	3/4" - 16	8	10	
	NA1117BL	-----	NS1117BL	-----	7/8" - 14	10	12	
	NA1118BL	-----	-----	-----	3/4" - 16	8	6	
 <p>90 DEGREE FEMALE FLARE (FF)</p>	NA1121BL	NA1121RB	NS1121BL	NS1121RB	5/8" - 18	6	6	
	NA1122BL	NA1122RB	NS1122BL	NS1122RB	3/4" - 16	8	8	
	NA1123BL	NA1123RB	NS1123BL	-----	7/8" - 14	10	10	
	NA1124BL	NA1124RB	NS1124BL	NS1124RB	1 1/16" - 14	12	12	
	NA1125BL	-----	-----	-----	5/8" - 18	6	8	
	NA1126BL	-----	NS1126BL	NS1126RB	3/4" - 16	8	10	
	NA1127BL	-----	NS1127BL	NS1127RB	7/8" - 14	10	12	
	NA1128BL	-----	NS1128BL	-----	3/4" - 16	8	6	
 <p>STRAIGHT MALE FLARE (MF)</p>	NA1201BL	-----	-----	-----				
	NA1202BL	-----	-----	-----				
	NA1203BL	-----	-----	-----				
	NA1204BL	-----	-----	-----				
 <p>90 DEGREE MALE FLARE (MF)</p>	NA1221BL	-----	-----	-----	5/8" - 18	6	6	
	NA1222BL	-----	-----	-----	3/4" - 16	8	8	
	NA1223BL	-----	-----	-----	7/8" - 14	10	10	
	NA1224BL	-----	-----	-----	1 1/16" - 14	12	12	

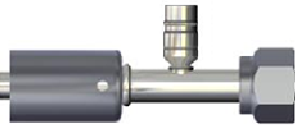

ILLUSTRATION	BLA	RBA	BLS	RBS	THREAD	A	B	PORT
 <p>STRAIGHT FEMALE O-RING (FOR)</p>	NA1301BL	NA1301RB	NS1301BL	NS1301RB	5/8" - 18	6	6	
	NA1302BL	NA1302RB	NS1302BL	NS1302RB	3/4" - 16	8	8	
	NA1303BL	NA1303RB	NS1303BL	NS1303RB	7/8" - 14	10	10	
	NA1304BL	NA1304RB	NS1304BL	NS1304RB	1 1/16" - 14	12	12	
	NA1305BL	NA1305RB	NS1305BL	NS1305RB	5/8" - 18	6	8	
	NA1306BL	NA1306RB	NS1306BL	NS1306RB	3/4" - 16	8	10	
	NA1307BL	NA1307RB	NS1307BL	NS1307RB	7/8" - 14	10	12	
	NA1308BL	NA1308RB	NS1308BL	-----	3/4" - 16	8	6	
	NA1310BL	NA1310RB	-----	NS1310RB	1 1/16 - 14	12	10	
	-----	-----	-----	NS13034RB	7/8" - 14	10	14	
-----	-----	-----	NS13044RB	1 1/16" - 14	12	14		
 <p>STRAIGHT FEMALE O-RING (FOR) WITH SWITCH OR SERVICE PORT</p>	NA1301-1BL	-----	NS1301-1BL	NS1301-1RB	5/8" - 18	6	6	1/4" R12
	NA1301-2BL	-----	-----	-----	5/8" - 18	6	6	3/16" R12
	NA1301-3BL	NA1301-3RB	NS1301-3BL	NS1301-3RB	5/8" - 18	6	6	16MM R134
	NA1301-4BL	-----	-----	-----	5/8" - 18	6	6	M10 SWP
	NA1302-1BL	NA130201RB	NS1302-1BL	NS1302-1RB	3/4" - 16	8	8	1/4" R12
	NA1302-2BL	-----	-----	-----	3/4" - 16	8	8	3/16" R12
	NA1302-3BL	NA1302-3RB	NS1302-3BL	NS1302-3RB	3/4" - 16	8	8	16MM R134
	NA1302-4BL	-----	-----	-----	3/4" - 16	8	8	M10 SWP
	NA1303-1BL	-----	NS1303-1BL	NS1303-1RB	7/8" - 14	10	10	1/4" R12
	NA1303-3BL	NA1303-3RB	NS1303-3BL	NS1303-3RB	7/8" - 14	10	10	13MM R134
	NA1303-5BL	-----	-----	-----	7/8" - 14	10	10	M12 SWP
	NA1303-9BL	-----	-----	-----	7/8" - 14	10	10	16MM R134
	NA1304-3BL	-----	NS1304-3BL	NS1304-3RB	1 1/16 - 14	12	12	13MM R134
	NA1304-5BL	-----	-----	-----	1 1/16 - 14	12	12	M12 SWP
NA1307-3BL	NA1307-3RB	NS1307-3BL	NS1307-3RB	7/8" - 14	10	12	13MM R134	
NA1308-3BL	-----	-----	-----	3/4" - 16	8	6	16MM R134	
 <p>45 DEGREE FEMALE O-RING (FOR)</p>	NA1311BL	NA1311RB	NS1311BL	NS1311RB	5/8" - 18	6	6	
	NA1312BL	NA1312RB	NS1312BL	NS1312RB	3/4" - 16	8	8	
	NA1313BL	NA1313RB	NS1313BL	NS1313RB	7/8" - 14	10	10	
	NA1314BL	NA1314RB	NS1314BL	NS1314RB	1 1/16 - 14	12	12	
	NA1315BL	NA1315RB	NS1315BL	NS1315RB	5/8" - 18	6	8	
	NA1316BL	NA1316RB	NS1316BL	NS1316RB	3/4" - 16	8	10	
	NA1317BL	NA1317RB	NS1317BL	NS1317RB	7/8" - 14	10	12	
 <p>45 DEGREE FEMALE O-RING (FOR) WITH SWITCH OR SERVICE PORT</p>	NA1311-1BL	-----	NS1311-1BL	NS1311-1RB	5/8" - 18	6	6	1/4" R12
	NA1311-3BL	NA1311-3RB	NS1311-3BB	NS1311-3RB	5/8" - 18	6	6	16MM R134
	NA1312-1BL	-----	NS1312-1BL	NS1312-1RB	3/4" - 16	8	8	1/4" R12
	NA1312-3BL	NA1312-3RB	NS1312-3BL	NS1312-3RB	3/4" - 16	8	8	16MM R134
	NA1313-1BL	-----	NS1313-1BL	NS1313-1RB	7/8" - 14	10	10	1/4" R12
	NA1313-3BL	NA1313-3RBL	NS1313-3BL	NS1313-3RB	7/8" - 14	10	10	13MM R134
	NA1317-3BL	-----	NS1317-SBL	NS1317-3RB	7/8" - 14	10	12	13MM R134





ILLUSTRATION	BLA	RBA	BLS	RBS	THREAD	A	B	PORT
 <p>90 DEGREE FEMALE O-RING (FOR)</p>	NA1321BL	NA1321RB	NS1312BL	NS1321RB	5/8" - 18	6	6	
	NA1322BL	NA1322RB	NS1322BL	NS1322RB	3/4" - 16	8	8	
	NA1323BL	NA1323RB	NS1323BL	NS1323RB	7/8" - 14	10	10	
	NA1324BL	NA1324RB	NS1324BL	NS1324RB	1 1/16" - 14	12	12	
	NA1325BL	NA1325RB	NS1325BL	-----	5/8" - 18	6	8	
	NA1326BL	NA1326RB	NS1326BL	NS1326RB	3/4" - 16	8	10	
	NA1327BL	NA1327RB	NS1327BL	NS1327RB	7/8" - 14	10	12	
	NA1328BL	NA1328RB	NS1328BL	-----	3/4" - 16	8	6	
	NA1330BL	NA1330RB	NS1330BL	NS1330RB	1 1/16" - 14	12	10	
	-----	-----	-----	NS132345RB	7/8" - 14	10	14	
-----	-----	-----	NS13244RB	1 1/16" - 14	12	14		
 <p>90 DEGREE FEMALE O-RING (FOR) WITH SWITCH OR SERVICE PORT</p>	NA1321-1BL	-----	NS1321-1BL	NS1321-1RB	5/8" - 18	6	6	1/4" R12
	NA1321-3BL	NA1321-3RB	NS1321-3BL	NS1321-3RB	5/8" - 18	6	6	16MM R134
	NA1322-1BL	-----	NS1322-1BL	NS1322-1RB	3/4" - 16	8	8	1/4" R12
	NA1322-3BL	NA1322-3RB	NS1322-3BL	NS1322-3RB	3/4" - 16	8	8	16MM R134
	NA1323-1BL	-----	NS1323-1BL	NS1323-1RB	7/8" - 14	10	10	1/4" R12
	NA1323-3BL	NA1323-3RB	NS1323-3BL	NS1323-3RB	7/8" - 14	10	10	13MM R134
	NA1324-3BL	NA1324-3RB	-----	-----	1 1/16" - 14	12	12	
	NA1327-1BL	-----	NS1327-1BL	NS1327-1RB	7/8" - 14	10	12	1/4" R12
	NA1327-3BL	NA1327-3RB	NA1327-3BL	NS1327-3RB	7/8" - 14	10	12	13MM R134
	 <p>STRAIGHT MALE O-RING (MOR)</p>	NA1401BL	NA1401RB	NS1401BL	NS1401RB	5/8" - 18	6	6
NA1402BL		NA1402RB	NS1402BL	NS1402RB	3/4" - 18	8	8	
NA1403BL		NA1403RB	NS1403BL	NS1403RB	7/8" - 18	10	10	
NA1404BL		NA1404RB	NS1404BL	NS1404RB	1 1/16" - 16	12	12	
NA1405BL		-----	NS1405BL	NS1405RB	5/8" - 18	6	8	
NA1406BL		-----	-----	NS1406RB	3/4" - 18	8	10	
NA1407BL		NA1407RB	NS1407BL	NS1407RB	7/8" - 18	10	12	
NA1408BL		-----	NS1408BL	-----	3/4" - 18	8	6	
 <p>STRAIGHT MALE O-RING (MOR) WITH SWITCH OR SERVICE PORT</p>	NA1401-1BL	-----	NS1401-3BL	NS1401-3RB	5/8" - 18	6	6	16MM R134
	NA1403-3BL	-----	NS1403-3BL	-----	7/8" - 18	10	10	13MM R134
	NA1404-3BL	-----	NS1404-3BL	-----	1 1/16" - 16	12	12	13MM R134
	NA1407-3BL	-----	NS1407-3BL	-----	7/8" - 18	10	12	13MM R134



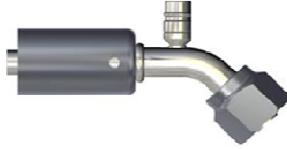

ILLUSTRATION	BLA	RBA	BLS	RBS	THREAD	A	B	PORT
 <p>45 DEGREE MALE O-RING (MOR)</p>	NA1411BL	NA1411RB	NS1411BL	NS1411RB	5/8" - 18	6	6	
	NA1412BL	NA1412RB	NS1412BL	NS1412RB	3/4" - 18	8	8	
	NA1413BL	NA1413RB	NS1413BL	NS1413RB	7/8" - 18	10	10	
	NA1414BL	NA1414RB	NS1414BL	NS1414RB	1 1/16" - 16	12	12	
	NA1415BL	-----	NS1415BL	NS1415RB	5/8" - 18	6	8	
	NA1418BL	-----	NS1418BL	-----	3/4" - 18	8	6	
 <p>90 DEGREE MALE O-RING (MOR)</p>	NA1421BL	NA1421RB	NS1421BL	NS1421RB	5/8" - 18	6	6	
	NA1422BL	NA1422RB	NS1422BL	NS1422RB	3/4" - 18	8	8	
	NA1423BL	NA1423RB	NS1423BL	NS1423RB	7/8" - 18	10	10	
	NA1424BL	NA1424RB	NS1424BL	NS1424RB	1 1/16" - 16	12	12	
	NA1425BL	-----	NS1425BL	NS1425RB	5/8" - 18	6	8	
	NA1427BL	NA1427RB	NS1427BL	NS1427RB	7/8" - 18	10	12	
	NA1428BL	-----	NS1428BL	-----	3/4" - 18	8	6	
 <p>90 DEGREE MALE O-RING (MOR) WITH SWITCH OR SERVICE PORT</p>	NA1421-3BL	-----	NS1421-3BL	NS1421-3RB	5/8" - 18	6	6	16MM R134
	NA1423-3BL	-----	NS1423-3BL	NS1423-3RB	3/4" - 18	10	10	13MM R134
	NA1427-3BL	-----	NS1427-3BL	-----	7/8" - 18	10	12	13MM R134
 <p>STRAIGHT MALE INSERT O-RING (MIO)</p>	NA1801BL	NA1801RB	NS1801BL	NS1801RB	5/8" - 18	6	6	
	NA1802BL	NA1802RB	NS1802BL	NS1802RB	3/4" - 16	8	8	
	NA1803BL	NA1803RB	NS1803BL	NS1803RB	7/8" - 14	10	10	
	NA1804BL	NA1804RB	NS1804BL	NS1804RB	1 1/16" - 14	12	12	









ILLUSTRATION	BLA	RBA	BLS	RBS	THREAD	A	B	PORT
 <p>45 DEGREE MALE INSERT O-RING (MIO)</p>	NA1811BL NA1812BL NA1813BL NA1814BL	NA1811RB NA1812RB NA1813RB -----	NS1811BL NS1812BL NS1813BL -----	----- ----- ----- -----	5/8" - 18 3/4" - 16 7/8" - 14 1 1/16"-14	6 8 10 12	6 8 10 12	
 <p>90 DEGREE MALE INSERT O-RING (MIO)</p>	NA1821BL NA1822BL NA1823BL NA1824BL	NA1821RB NA1822RB NA1823RB -----	NS1821BL NS1822BL NS1823BL -----	NS1821RB ----- NS1823RB -----	5/8" - 18 3/4" - 16 7/8" - 14 1 1/16" - 14	6 8 10 12	6 8 10 12	
 <p>180 DEGREE FEMALE O-RING (FOR)</p>	NA1931BL NA1932BL NA1933BL NA1934BL	----- NA1932RB ----- -----	NS1931BL NS1932BL NS1933BL NS1934BL	----- ----- NS1933RB -----	5/8" - 18 3/4" - 16 7/8" - 14 1 1/16" - 14	6 8 10 12	6 8 10 12	
 <p>STRAIGHT 7 MALE O-RING (MOR)</p>	NA1952BL	-----	NS1952BL	NS1952RB	1 1/16"	7	6	

ILLUSTRATION	BLA	RBA	BLS	RBS	THREAD	A	B	PORT
 <p>90 DEGREE 7 MALE O-RING (MOR)</p>	NA1953BL	-----	NS1953BL	NS1953RB	1 1/16"	7	6	
 <p>STRAIGHT FEMALE SPRINGLOCK (FSL)</p>	NA4101BL NA4102BL NA4103BL NA4104BL NA4107BL NA4108BL	-----	-----	-----	-----	6 8 10 12 10 8	6 8 10 12 12 6	
 <p>45 DEGREE FEMALE SPRINGLOCK (FSL)</p>	NA4111BL NA4112BL NA4113BL NA4114BL NA4117BL NA4118BL	-----	-----	-----	-----	6 8 10 12 10 8	6 8 10 12 12 6	
 <p>90 DEGREE FEMALE SPRINGLOCK (FSL)</p>	NA4121BL NA4122BL NA4123BL NA4124BL NA4127BL NA4128BL	-----	-----	-----	-----	6 8 10 12 10 8	6 8 10 12 12 6	

Note: "A" = Fitting Size , "B" = Hose Size





ILLUSTRATION	BLA	RBA	BLS	RBS	THREAD	A	B	PORT
 <p>STRAIGHT MALE SPRINGLOCK (MSL) (O-RINGS AND SPRINGS IN-</p>	NA4301BL NA4302BL NA4203BL NA4204BL NA4308BL	-----	-----	-----	-----	6 8 10 12 8	6 8 10 12 6	
 <p>45 DEGREE MALE SPRINGLOCK (MSL) (O-RINGS & SPRINGS IN-</p>	NA4311BL NA4312BL NA4313BL NA4314BL NA4318BL	-----	-----	-----	-----	6 8 10 12 8	6 8 10 12 6	
 <p>90 DEGREE MALE SPRINGLOCK (MSL) (O-RINGS & SPRINGS IN-</p>	NA4321BL NA4322BL NA4323BL NA4324BL NA4327BL NA4328BL	-----	-----	-----	-----	6 8 10 12 10 8	6 8 10 12 12 6	
 <p>STRAIGHT SPLICER</p>	NA6101BL NA6102BL NA6103BL NA6104BL NA6105BL NA6106BL NA6107BL	NA6101RB NA6102RB NA6103RB NA6104RB NA6105RB NA6106RB NA6107RB	NS6101BL NS6102BL NS6103BL NS6104BL NS6105BL NS6106BL NS6107BL	NS6101RB NS6102RB NS6103RB NS6104RB NS6105RB NS6106RB NS6107RB	6 X 6 8 X 8 10 X 10 12 X 12 6 X 8 8 X 10 10 X 12	6 8 10 12 6 8 10	6 8 10 12 8 10 12	



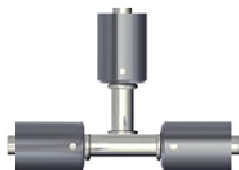

ILLUSTRATION	BLA	RBA	BLS	RBS	THREAD	A	B	PORT
 <p>STRAIGHT SPLICER WITH SWITCH OR SERVICE PORT</p>	NA6101-1BL	NA6101-1RB	NS6101-1BL	NS6101-1RB	6 X 6	6	6	1/4" R12
	NA6101-2BL	-----	-----	-----	6 X 6	6	6	7/16-20 THD
	NA6101-3BL	NA6101-3RB	NS6101-3BL	NS6101-3RB	6 X 6	6	6	16MM R134
	NA6102-1BL	-----	NS6102-1BL	NS6102-1RB	8 X 8	8	8	1/4" R12
	NA6102-2BL	-----	-----	-----	8 X 8	8	8	7/16-20 THD
	NA6102-3BL	NA6102-3RB	NS6102-3BL	NS6102-3RB	8 X 8	8	8	16MM R134
	NA6103-1BL	NA6103-1RB	NS6103-1BL	NS6103-1RB	10 X 10	10	10	1/4" R12
	NA6103-3BL	NA6103-3RB	NS6103-3BL	NS6103-3RB	10 X 10	10	10	13MM R134
	NA6103-9BL	-----	-----	-----	10 X 10	10	10	16MM R134
	NA6104-1BL	-----	NS6104-1BL	-----	12 X 12	12	12	1/4" R12
	NA6104-3BL	NA6104-3RB	NS6104-3BL	NS6104-3RB	12 X 12	12	12	13MM R134
	-----	-----	-----	-----	NS6106-1RB	6 X 6	6	6
 <p>90 DEGREE SPLICER</p>	NA6121BL	-----	NS6121BL	-----	6 X 6	6	6	
	NA6122BL	-----	NS6122BL	NS6122RB	8 X 8	8	8	
	NA6123BL	-----	NS6123BL	-----	10 X 10	10	10	
	NA6124BL	-----	NS6124BL	NS6124RB	12 X 12	12	12	
 <p>T - SPLICER 3 WAY BEADLOCK</p>	NA6201BL	NA6201RB	NS6201BL	-----	6X6X6			
	NA6202BL	-----	NS6202BL	-----	6X8X8			
	NA6203BL	-----	NS6203BL	-----	10X10X10			
	NA6204BL	NA6204RB	NS6204BL	NS6204RB	12X12X12			
	NA6210BL	-----	NS6210BL	-----	12X12X10			
 <p>STRAIGHT WELD-ON BEADLOCK ENDS OUTER</p>	NA6601BL	NA6601RB	NS6601BL	NS6601RB	3/8" TUBE	6	6	
	NA6602BL	NA6602RB	NS6602BL	NS6602RB	1/2" TUBE	8	8	
	NA6603BL	NA6603RB	NS6603BL	NS6603RB	5/8" TUBE	10	10	
	NA6604BL	NA6604RB	NS6604BL	NS6604RB	3/4" TUBE	12	12	
	NA6605BL	NA6605RB	NS6605BL	NS6605RB	5/8" TUBE	10	12	



ILLUSTRATION	BLA	RBA	BLS	RBS	THREAD	A	B	PORT
 <p>STRAIGHT FEMALE O-RING (FOR) METRIC</p>	NA9301BL	-----	NS9301BL	-----	9/16" X 18	5	6	
	NA9302BL	-----	NS9302BL	-----	M16 X 1.5	M16	6	
	NA9303BL	-----	NS9303BL	-----	M18 X 1.5	M18	6	
	NA9304BL	-----	NS9304BL	-----	M20 X 1.5	M20	6	
	NA9305BL	NA9305RB	NS9305BL	NS9305RB	M20 X 1.5	M20	8	
	NA9306BL	-----	-----	-----	M22 X 1.5	M22	10	
	NA9307BL	-----	-----	-----	M24 X 2.0	M24	10	
	NA9308BL	-----	-----	-----	M27 X 2.0	M27	12	
 <p>45 DEGREE FEMALE O-RING (FOR) METRIC</p>	NA9311BL	-----	NS9311BL	-----	9/16" X 18	5	6	
	NA9312BL	-----	NS9312BL	-----	M16 X 1.5	M16	6	
	NA9313BL	NA9313RB	-----	NS9313RB	M18 X 1.5	M18	6	
	NA9314BL	NA9314RB	-----	-----	M20 X 1.5	M20	6	
	NA9315BL	NA9315RB	-----	NS9315RB	M20 X 1.5	M20	8	
	NA9316BL	-----	-----	-----	M22 X 1.5	M22	10	
	NA9317BL	-----	-----	-----	M24 X 2.0	M24	10	
	NA9318BL	NA9318RB	-----	NS9318BL	M27 X 2.0	M27	12	
 <p>90 DEGREE FEMALE O-RING (FOR) METRIC</p>	NA9321BL	-----	NS9321BL	-----	9/16" X 18	5	6	
	NA9322BL	-----	NS9322BL	-----	M16 X 1.5	M16	6	
	NA9323BL	NA9323RB	NS9323RL	-----	M18 X 1.5	M18	6	
	NA9324BL	-----	NS9324BL	-----	M20 X 1.5	M20	6	
	NA9325BL	NA9325RB	NS9325BL	NS9325RB	M20 X 1.5	M20	8	
	NA9326BL	-----	-----	-----	M22 X 1.5	M22	10	
	NA9327BL	-----	NS9327BL	-----	M24 X 2.0	M24	10	
	NA9328BL	NA9328RB	-----	NS9328RB	M27 X 2.0	M27	12	

ILLUSTRATION	BBA	THREAD	B	COMMENTS
 <p>STRAIGHT WELD ON (INNER)</p>	NBBA5801 NBBA5801A NBBA5802 NBBA5802A NBBA5803 NBBA5803A NBBA5804 NBBA5804A	5/16" - 049W 5/16" - 049W 1/2" - 049W 1/2" - 049W 5/8" - 049W 5/8" - 049W 3/4" - 049W 3/4" - 049W	6 6 8 8 10 10 12 12	I.D. FITTING - STEEL I.D. FITTING - ALUMINUM I.D. FITTING STEEL I.D. FITTING ALUMINUM I.D. FITTING STEEL I.D. FITTING ALUMINUM I.D. FITTING STEEL I.D. FITTING ALUMINUM
 <p>STRAIGHT WELD ON (OUTER)</p>	NBBA5821 NBBA5821A NBBA5822 NBBA5822A NBBA5823 NBBA5823A NBBA5824 NBBA5824A	5/16" - 049W 5/16" - 049W 1/2" - 049W 1/2" - 049W 5/8" - 049W 5/8" - 049W 3/4" - 049W 3/4" - 049W	6 6 8 8 10 10 12 12	I.D. FITTING - STEEL I.D. FITTING - ALUMINUM I.D. FITTING STEEL I.D. FITTING ALUMINUM I.D. FITTING STEEL I.D. FITTING ALUMINUM I.D. FITTING STEEL I.D. FITTING ALUMINUM





ILLUSTRATION	BLA	RBA	BLS	RBS	THREAD	A	B	PORT
 <p>135 DEG. FEMALE O-RING</p>	NA1332BL NA1333BL	----- -----	NS1332BL NS1333BL	----- -----	3/4/2016 7/8/2014	8 10	8 10	
 <p>135 DEG. FEMALE O-RING W/ R134a SERVICE PORT</p>	NA1332-3BL NA1333-3BL	----- -----	NS1332-3BL NS1333-3BL	----- -----	3/4/2016 7/8/2014	8 10	8 10	R134a PORT R134a PORT
 <p>GM DUAL COMPRESSOR BLOCK UNIVERSIAL SWIVEL 90 DEG. ELBOW</p>	NA1900BL	-----	-----	-----	GM	8	12	
 <p>GM DUAL COMPRESSOR BLOCK UNIVERSIAL SWIVEL 180 DEG. ELBOW</p>	NA1908BL	-----	-----	-----	GM	8	12	

ILLUSTRATION	BLA	RBA	BLS	RBS	THREAD	A	B	PORT
 <p data-bbox="168 407 435 499">GM DUAL PORT COMPRESSOR BLOCK STRAOGJT</p>	NA1920BL	----	----	----	N/A	8	12	
 <p data-bbox="159 842 444 934">ADAPTER TUBE -O TO ROTOLOCK STRAIGHT</p>	----	----	NS1954	----				
 <p data-bbox="164 1346 440 1438">ADAPTER ROTOLOCK TO TUBE-O STRAIGHT</p>	----	----	NS1955	----	1 - 14			
 <p data-bbox="168 1881 435 1974">ADAPTER FLANGE TO TUBE-O 90 DEG. ELBOW (OUT)</p>		----	NS1956	----	1 - 14			







ILLUSTRATION	BLA	RBA	BLS	RBS	THREAD	A	B	PORT
 <p>ADAPTER FLANGE TO ROTOLOCK STRAIGHT</p>	----	----	NS1957	----	1 - 14			
 <p>ADAPTER FLARE TO O-RING STRAIGHT</p>	----	----	NS2606 NS2608 NS2609 NS2610	----	5/8 - 18 3/4 - 16 7/8 - 14 7/8 - 14			6 MF TO 6 MIO 8 MF TO 8 MIO 10MF TO 10MIO 8 MF TO 10 MIO
 <p>GM COMPRESSOR PAD BLOCK (SINGLE) W/R12 PORT 90 DEG. ELBOW (IN)</p>	NA5622-1BL NA5623-1BL NA5624-1BL	----	NS5622-1BL NS5623-1BL NS5624-1BL	----	N/A N/A N/A		8 10 12	
 <p>GM COMPRESSOR PAD BLOCK (SINGLE) W/R12 PORT 90 DEG. ELBOW (OUT)</p>	NA5625-1BL NA5626-1BL NA5627-1BL	----	NS5625-1BL NS5626-1BL NS5627-1BL	----	N/A N/A N/A		8 10 12	

ILLUSTRATION	BLA	RBA	BLS	RBS	THREAD	A	B	PORT
 <p>SPLICER - 180 DEG. ELBOW</p>	NA6131BL NA6132BL NA6133BL NA6134BL	---- ---- ---- ----	---- ---- ---- ----	---- ---- ---- ----	N/A N/A N/A N/A	6 8 10 12	6 8 10 12	
 <p>UNIVERSAL T - SPLICER</p>	NA6225BL NA6226BL NA6235BL NA6236BL	---- ---- ---- ----	NS6225BL NS6226BL NS6235BL NS6236BL	---- ---- ---- ----	5/8/2018 3/4/2016 7/8/2014 1 1/16 - 14	6 8 10 12	6 8 10 12	
 <p>FORD T-SPLICER SPRINGLOCK</p>	NA6294BL NA6298BL	---- ----	---- ----	---- ----	N/A N/A	8 12	6 10	
 <p>FORD T-SPLICER LIQUID LINE SPRINGLOCK</p>	NA6295BL	----	----	----	N/A	8	6	

NA0335

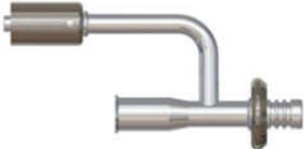

GM Style Horizontal Raised Face Compressor Block
#8 - 3/4" - Thread & #10 - 7/8" - 14 Thread

NA0336

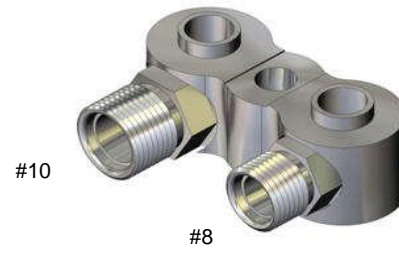

GM Style Vertical Flat Face Compressor Block
#8 - 3/4" - Thread & #10 - 7/8" - 14 Thread

NA0337



GM Style Horizontal Flat Face Compressor Block
#8 - 3/4" - Thread & #10 - 7/8" - 14 Thread

NA0338



GM Style Vertical Flat Face Compressor Block
#10 - 7/8" - 14 Thread & #12 - 1 1/16" - 14 Thread

NA0442



GM LS1 Style Horizontal Offset Raised Face
Compressor Block.

NA0443

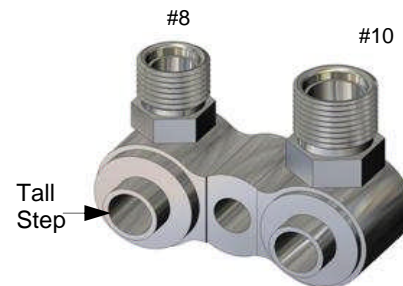

GM LS1 Style Vertical Raised Face Compressor Block
#10 - 7/8" - 14 Thread & #12 - 1 1/16" - 14 Thread

NA0738



Peanut Style Compressor Block GM/Denso 10S20F
W/ #8 Male Insert O-Ring Hose Fitting

NA0739



Peanut Style Compressor Block GM/Denso 10S20F
W/ #10 Male Insert O-Ring Hose Fitting

NA0753



Ford Style FS10 Compressor Block
W/ #8 - 3/4" - 16 Thread & #10 - 7/8" - 14 Thread

NC0944



Peanut Style Compressor Block GM/Sanden SD7Comp.
W/ #8 Male Insert O-Ring Hose Connection

NC0945



Peanut Style Compressor Block GM/Sanden SD7
Compressor Block/

NA1075

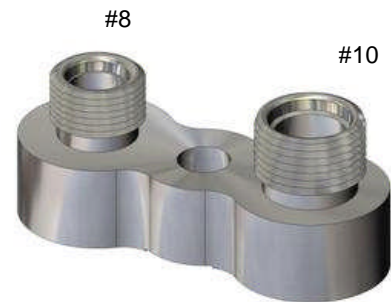

GM Style Horizontal Flat Face Compressor Block
BILLET MACHINED, #8 - 3/4"-16 Thrd,& #10-7/8"-14

NA1109



Denso/Komatsu 10PA15C OEM Compressor Pad
W/ #10 Male Insert O-Ring Hose Connection

NA1110



Denso/Komatsu 10PA15C OEM Compressor Pad
W/ #8 Male Insert O-Ring Hose Connection

NA1288

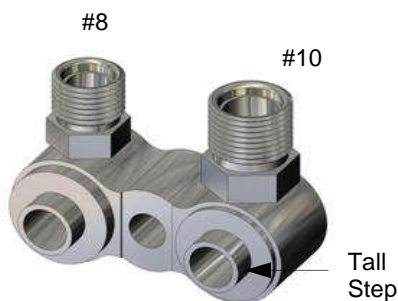

GMLS1 Style Vertical Compressor Block
3/ #8 - 3/4" - 16 Thread & #10 - 7/8" - 14 Thread

NA1319

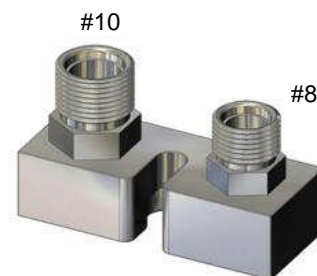

Ford Style Compressor Block
W/ #8 - 3/4" - 16 Thread & #10 - 7/8" - 14 Thread

NA1401



Ford Style Compressor Block
#8 - 3/4" - 16 Thread & #10 - 7/8" - 14 Thread

NA1414

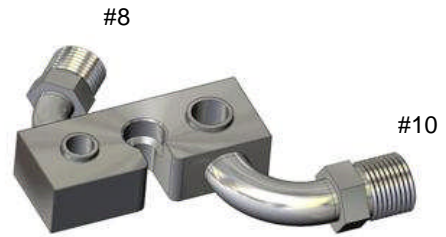

Ford Style FS10 Compressor Block
#8 - 3/4" - 16 Thread & #10 - 7/8" - 14 Thread

<u>NITCOM NO.</u>	<u>PAGE NO.</u>	<u>NITCOM NO.</u>	<u>PAGE NO.</u>	<u>NITCOM NO.</u>	<u>PAGE NO.</u>	<u>NITCOM NO.</u>	<u>PAGE NO.</u>
NA0335	15	NA1224BL	1	NA1404BL	3	NA4308BL	7
NA0336	15	NA1301BL	2	NA1404-3BL	3	NA4311BL	7
NA0337	15	NA1301-1BL	2	NA1405BL	3	NA4312BL	7
NA0338	15	NA1301-2BL	2	NA1406BL	3	NA4313BL	7
NA0442	15	NA1301-3BL	2	NA1407BL	3	NA4314BL	7
NA0443	15	NA1302BL	2	NA1407-3BL	3	NA4317BL	7
NA0738	15	NA1302-2BL	2	NA1408BL	3	NA4318BL	7
NA0739	15	NA1302-3BL	2	NA1411BL	4	NA4321BL	7
NA0753	16	NA1302-4BL	2	NA1412BL	4	NA4322BL	7
NA1075	16	NA1303BL	2	NA1413BL	4	NA4323BL	7
NA1109	16	NA1303-1BL	2	NA1414BL	4	NA4324BL	7
NA1110	16	NA1303-3BL	2	NA1415BL	4	NA4327BL	7
NA1288	16	NA1303-5BL	2	NA1418BL	4	NA4328BL	7
NA1319	16	NA1303-9BL	2	NA1421BL	4	NA5622-1BL	13
NA1401	17	NA1304BL	2	NA1421-3BL	4	NA5623-1BL	13
NA1414	17	NA1304-3BL	2	NA1422BL	4	NA5624-1BL	13
NC0944	16	NA1304-5BL	2	NA1423BL	4	NA5625-1BL	13
NC0945	16	NA1305BL	2	NA1423-3BL	4	NA5626-1BL	13
NBBA5801	10	NA1306BL	2	NA1424BL	4	NA5627-1BL	13
NBBA5801A	10	NA1307BL	2	NA1425BL	4	NA6101BL	7
NBBA5802	10	NA1307-3BL	2	NA1427BL	4	NA6101-1BL	8
NBBA5802A	10	NA1308BL	2	NA1427-3BL	4	NA6101-2BL	8
NBBA5803	10	NA1308-3BL	2	NA1428BL	4	NA6101-3BL	8
NBBA5803A	10	NA1310BL	2	NA1801BL	4	NA6102BL	7
NBBA5804	10	NA1311BL	2	NA1802BL	4	NA6102-1BL	8
NBBA5804A	10	NA1311-1BL	2	NA1803BL	4	NA6102-2BL	8
NBBA5821	10	NA1311-3BL	2	NA1804BL	4	NA6102-3BL	8
NBBA5821A	10	NA1312BL	2	NA1811BL	5	NA6103BL	7
NBBA5822	10	NA1312-1BL	2	NA1812BL	5	NA6103-1BL	8
NBBA5822A	10	NA1312-3BL	2	NA1813BL	5	NA6103-3BL	8
NBBA5823	10	NA1313BL	2	NA1814BL	5	NA6103-9BL	8
NBBA5823A	10	NA1313-1BL	2	NA1821BL	5	NA6104BL	7
NBBA5824	10	NA1313-3BL	2	NA1822BL	5	NA6104-1BL	8
NBBA5824A	10	NA1314BL	2	NA1823BL	5	NA6104-3BL	8
NA1101BL	1	NA1315BL	2	NA1824BL	5	NA6105BL	7
NA1102BL	1	NA1316BL	2	NA1900BL	11	NA6106BL	7
NA1103BL	1	NA1317BL	2	NA1908BL	11	NA6107BL	7
NA1104BL	1	NA1317-3BL	2	NA1920BL	12	NA6121BL	8
NA1105BL	1	NA1321BL	3	NA1931BL	5	NA6122BL	8
NA1106BL	1	NA1321-1BL	3	NA1932BL	5	NA6123BL	8
NA1107BL	1	NA1321-3BL	3	NA1934BL	5	NA6124BL	8
NA1108BL	1	NA1322BL	3	NA1952BL	5	NA6131BL	14
NA1111BL	1	NA1322-1BL	3	NA1953BL	6	NA6132BL	14
NA1112BL	1	NA1322-3BL	3	NA4101BL	6	NA6133BL	14
NA1113BL	1	NA1323BL	3	NA4102BL	6	NA6134BL	14
NA1114BL	1	NA1323-1BL	3	NA4104BL	6	NA6201BL	8
NA1115BL	1	NA1323-3BL	3	NA4107BL	6	NA6202BL	8
NA1116BL	1	NA1324BL	3	NA4108BL	6	NA6203BL	8
NA1117BL	1	NA1324-3BL	3	NA4111BL	6	NA6204BL	8
NA1118BL	1	NA1325BL	3	NA4112BL	6	NA6210BL	8
NA1121BL	1	NA1326BL	3	NA4113BL	6	NA6225BL	14
NA1122BL	1	NA1327BL	3	NA4114BL	6	NA6226BL	14
NA1123BL	1	NA1327-1BL	3	NA4117BL	6	NA6235BL	14
NA1124BL	1	NA1327-3 BL	3	NA4118BL	6	NA6236BL	14
NA1125BL	1	NA1328BL	3	NA4121BL	6	NA6294BL	14
NA1126BL	1	NA1330BL	3	NA4122BL	6	NA6295BL	14
NA1127BL	1	NA1332BL	11	NA4123BL	6	NA6298BL	14
NA1128BL	1	NA1332-3BL	11	NA4124BL	6	NA6601BL	8
NA1201BL	1	NA1333BL	11	NA4127BL	6	NA6602BL	8
NA1202BL	1	NA1333-3BL	11	NA4128BL	6	NA6603BL	8
NA1203BL	1	NA1401BL	3	NA4301BL	7	NA6604BL	8
NA1204BL	1	NA1401-3BL	3	NA4302BL	7	NA6605BL	8
NA1221BL	1	NA1402BL	3	NA4303BL	7	NA9301BL	9
NA1222BL	1	NA1403BL	3	NA4304BL	7	NA9302BL	9
NA1223BL	1	NA1403-3BL	3	NA4307BL	7	NA9303BL	9

<u>NITCOM NO.</u>	<u>PAGE NO.</u>	<u>NITCOM NO.</u>	<u>PAGE NO.</u>	<u>NITCOM NO.</u>	<u>PAGE NO.</u>	<u>NITCOM NO.</u>	<u>PAGE NO.</u>
NA9304BL	9	NA1325RB	3	NS1107BL	1	NS1333-3BL	11
NA9305BL	9	NA1326RB	3	NS1108BL	1	NS1401BL	3
NA9306BL	9	NA1327RB	3	NS1111BL	1	NS1401-3BL	3
NA9307BL	9	NA1327-3RB	3	NS1112BL	1	NS1402BL	3
NA9308BL	9	NA1328RB	3	NS1113BL	1	NS1403BL	3
NA9311BL	9	NA1330RB	3	NS1114BL	1	NS1403-3BL	3
NA9312BL	9	NA1401RB	3	NS1117BL	1	NS1404BL	3
NA9313BL	9	NA1402RB	3	NS1121BL	1	NS1404-3BL	3
NA9314BL	9	NA1403RB	3	NS1122BL	1	NS1405BL	3
NA9315BL	9	NA1404RB	3	NS1123BL	1	NS1407BL	3
NA9316BL	9	NA1407RB	3	NS1124BL	1	NS1407-3BL	3
NA9317BL	9	NA1411RB	4	NS1125BL	1	NS1408BL	3
NA9318BL	9	NA1412RB	4	NS1126BL	1	NS1411BL	4
NA9321BL	9	NA1413RB	4	NS1127BL	1	NS1412BL	4
NA9322BL	9	NA1414RB	4	NS1128BL	1	NS1413BL	4
NA9323BL	9	NA1415RB	4	NS1301BL	2	NS1414BL	4
NA9324BL	9	NA1418RB	4	NS1301-1BL	2	NS1415BL	4
NA9325BL	9	NA1421RB	4	NS1301-3BL	2	NS1421BL	4
NA9326BL	9	NA1422RB	4	NS1302BL	2	NS1421-3BL	4
NA9327BL	9	NA1423RB	4	NS1302-1BL	2	NS1422BL	4
NA9328BL	9	NA1424RB	4	NS1302-3BL	2	NS1423BL	4
NA1101RB	1	NA1427RB	4	NS1303BL	2	NS1423-3BL	4
NA1102RB	1	NA1801RB	4	NS1303-1BL	2	NS1424BL	4
NA1103RB	1	NA1802RB	4	NS1303-3BL	2	NS1427-3BL	4
NA1104RB	1	NA1803RB	4	NS1304BL	2	NS1425BL	4
NA1105RB	1	NA1804RB	4	NS1304-3BL	2	NS1427BL	4
NA1106RB	1	NA1811RB	5	NS1305BL	2	NS1428BL	4
NA1111RB	1	NA1812RB	5	NS1306BL	2	NS1801BL	4
NA1112RB	1	NA1813RB	5	NS1307BL	2	NS1802BL	4
NA1113RB	1	NA1821RB	5	NS1307-3BL	2	NS1803BL	4
NA1114RB	1	NA1822RB	5	NS1308BL	2	NS1804BL	4
NA1121RB	1	NA1823RB	5	NS1311BL	2	NS1811BL	5
NA1122RB	1	NA1932RB	5	NS1311-1BL	2	NS1812BL	5
NA1123RB	1	NA6101RB	7	NS1311-3BL	2	NS1813BL	5
NA1124RB	1	NA6101-1RB	8	NS1312BL	2	NS1821BL	5
NA1301RB	2	NA6101-3RB	8	NS1312-1BL	2	NS1822BL	5
NA1301-3RB	2	NA6102RB	7	NS1312-3BL	2	NS1823BL	5
NA1302RB	2	NA6102-3RB	8	NS1313BL	2	NS1931BL	5
NA1302-1RB	2	NA6103RB	7	NS1313-1BL	2	NS1932BL	5
NA1302-3RB	2	NA6103-1RB	8	NS1313-3BL	2	NS1933BL	5
NA1303RB	2	NA6103-3RB	8	NS1314BL	2	NS1934BL	5
NA1303-3RB	2	NA6104RB	7	NS1315BL	2	NS1952BL	5
NA1304RB	2	NA6104-3RB	8	NS1316BL	2	NS1953BL	6
NA1305RB	2	NA6105RB	7	NS1317BL	2	NS1954BL	12
NA1306RB	2	NA6106RB	7	NS1317-3BL	2	NS1955BL	12
NA1307RB	2	NA6107RB	7	NS1321BL	3	NS1956BL	12
NA1307-3RB	2	NA6201RB	8	NS1321-1BL	3	NS1957	13
NA1318RB	2	NA6204RB	8	NS1321-3BL	3	NS2606	13
NA1310RB	2	NA6601RB	8	NS1322BL	3	NS2608	13
NA1311RB	2	NA6602RB	8	NS1322-1BL	3	NS2609	13
NA1312RB	2	NA6603RB	8	NS1322-3BL	3	NS2610	13
NA1312-3RB	2	NA6604RB	8	NS1323BL	3	NS5622-1BL	13
NA1313RB	2	NA6605RB	8	NS1323-1BL	3	NS5623-1BL	13
NA1313-3RB	2	NA9305RB	9	NS1323-3BL	3	NS5624-1BL	13
NA1314RB	2	NA9313RB	9	NS1324BL	3	NS5625-1BL	13
NA1315RB	2	NA9314RB	9	NS1325BL	3	NS5626-1BL	13
NA1316RB	2	NA9315RB	9	NS1326BL	3	NS5627-1BL	13
NA1317RB	2	NA9318RB	9	NS1327BL	3	NS6101BL	7
NA1321RB	3	NA9323RB	9	NS1327-1BL	3	NS6101-1BL	8
NA1321-3RB	3	NA9325RB	9	NS1327-3BL	3	NS6101-3BL	8
NA1322RB	3	NA9328RB	9	NS1328BL	3	NS6102BL	7
NA1322-3RB	3	NS1101BL	1	NS1330BL	3	NS6102-1BL	8
NA1323RB	3	NS1102BL	1	NS1332BL	11	NS6102-3BL	8
NA1323-3RB	3	NS1103BL	1	NS1332-3BL	11	NS6103BL	7
NA1324RB	3	NS1105BL	1	NS1333BL	11	NS6103-1BL	8

<u>NITCOM NO.</u>	<u>PAGE NO.</u>	<u>NITCOM NO.</u>	<u>PAGE NO.</u>	<u>NITCOM NO.</u>	<u>PAGE NO.</u>	<u>NITCOM NO.</u>	<u>PAGE NO.</u>
NS6103-3BL	8	NS1312RB	2	NS6107RB	7		
NS6104BL	7	NS1312-1RB	2	NS6101-1RB	8		
NS6104-1BL	8	NS1312-3RB	2	NS6101-3RB	8		
NS6104-3BL	8	NS1313RB	2	NS6102-1RB	8		
NS6105BL	7	NS1313-1RB	2	NS6102-3RB	8		
NS6106BL	7	NS1313-3RB	2	NS6103-1RB	8		
NS6107BL	7	NS1314RB	2	NS6103-3RB	8		
NS6121BL	8	NS1315RB	2	NS6104-3RB	8		
NS6122BL	8	NS1316RB	2	NS6106-1RB	8		
NS6123BL	8	NS1317RB	2	NS6122RB	8		
NS6124BL	8	NS1317-3RB	2	NS6124RB	8		
NS6201BL	8	NS1321RB	3	NS6204RB	8		
NS6202BL	8	NS1321-1RB	3	NS6601RB	8		
NS6203BL	8	NS1321-3RB	3	NS6602RB	8		
NS6204BL	8	NS1322RB	3	NS6603RB	8		
NS6210BL	8	NS1322-1RB	3	NS6604RB	8		
NS6225BL	14	NS1322-3RB	3	NS6605RB	8		
NS6226BL	14	NS1323RB	3	NS9305RB	9		
NS6235BL	14	NS1323-1RB	3	NS9313RB	9		
NS6236BL	14	NS1323-3RB	3	NS9315RB	9		
NS6601BL	8	NS1324RB	3	NS9318RB	9		
NS6602BL	8	NS1325RB	3	NS9325RB	9		
NS6603BL	8	NS1326RB	3	NS9328RB	9		
NS6604BL	8	NS1327RB	3				
NS6605BL	8	NS1327-1RB	3				
NS9301BL	9	NS1327-3RB	3				
NS9302BL	9	NS1330RB	3				
NS9303BL	9	NS13234RB	3				
NS9304BL	9	NS13244RB	3				
NS9305BL	9	NS1401RB	3				
NS9311BL	9	NS1401-3RB	3				
NS9312BL	9	NS1402RB	3				
NS9321BL	9	NS1403RB	3				
NS9322BL	9	NS1404RB	3				
NS9323BL	9	NS1405RB	3				
NS9324BL	9	NS1406RB	3				
NS9325BL	9	NS1407RB	3				
NS9327BL	9	NS1411RB	4				
NS1101RB	1	NS1412RB	4				
NS1116RB	1	NS1413RB	4				
NS1121RB	1	NS1414RB	4				
NS1122RB	1	NS1415RB	4				
NS1124RB	1	NS1421RB	4				
NS1127RB	1	NS1421-3RB	4				
NS1301RB	2	NS1422RB	4				
NS1301-1RB	2	NS1423RB	4				
NS1301-3RB	2	NS1423-3RB	4				
NS1302RB	2	NS1424RB	4				
NS1302-1RB	2	NS1425RB	4				
NS1302-3RB	2	NS1427RB	4				
NS1303RB	2	NS1801RB	4				
NS1303-1RB	2	NS1802RB	4				
NS1303-3RB	2	NS1803RB	4				
NS1304RB	2	NS1804RB	4				
NS1304-3RB	2	NS1821RB	5				
NS1305RB	2	NS1823RB	5				
NS1306RB	2	NS1933RB	5				
NS1307RB	2	NS1952RB	5				
NS1307-3RB	2	NS1953RB	6				
NS1310RB	2	NS6101RB	7				
NS13034RB	2	NS6102RB	7				
NS13044RB	2	NS6103RB	7				
NS1311RB	2	NS6104RB	7				
NS1311-1RB	2	NS6105RB	7				
NS1311-3RB	2	NS6106RB	7				